

EATON SAFELITE BK2-DALI-Z EMERGENCY LIGHT

Brand: **Eaton** | Category: **BK2-DALI-Z Emergency Light**

| | |
|--------------------------------------|--|
| Product Datasheet | Website Know More PDF |
| Recommended Website Card Name | EATON SAFELITE BK2-DALI-Z EMERGENCY LIGHT |
| Source Datasheet | Emergency - Exit Light & Controller DATASHEET - EATON Brand.pdf |

CGLine+ self-contained luminaire system
CGLine+ Web Compact Controller



CGLine+ Web Compact Controller

- For connecting up to 160 or 400 luminaires in 2 lines
- HMI with TFT LCD screen 320*480 and keypad
- TP predictive test for fireproof stage of the keypad
- Led status for Emergency Lighting Installation
- The integrated web server enables there to be convenient visualization, control and monitoring
- Up to 9 additional web compact controllers managed within the same web server connection
- Unique ID per luminaire assigned by the manufacturer
- Automatic luminaire search function requiring no manual addressing
- Simple sorting using unrestricted short address assignment
- Unrestricted entry of target location names for the luminaires with up to 20 characters
- Clearly-shown allocation of luminaires to 4 zones of 20 luminaires per line
- Automatic function test and duration test
- Up to 8 test groups per luminaire can be defined for the function test (FT) and duration test (DT)
- Electronic log book storage for a period of minimum 4 years
- E-mail service for sending automatic e-mail in case of malfunctions to up to 10 e-mail addresses, assignable to 2 escalation groups
- Blocking the emergency lighting function during non-operational periods (all/per bus line/per zone/per luminaire)
- Luminaires in maintained mode switchable (all/per bus line/per zone/per luminaire)
- Password protected access as an administrator or user
- Visualisation of luminaires in up to 30 different building layouts with the web server
- Efficient and convenient analysis of the log book using the CGLine+ PC software
- Compliant with the highest industry cybersecurity requirements
- Maintenance and replacement of luminaire with the local HMI
- Maintenance and replacement of luminaire with the web server interface
- Compatible with the new increased affordance (AI) functionality

Dimensional drawings, data in mm



| | |
|---------------------------------|---------------------------------------|
| Dimensions | 288 x 203 x 60 mm |
| Housing type | Wall mounted |
| Screen | 3,5 inch TFT LCD screen (320 x 480) |
| Power supply | 230 V AC, 50/60 Hz |
| Power consumption | < 4 W in standby, < 34 W at full load |
| Connection terminals | max. 2,5 mm ² |
| Permissible ambient temperature | 0 °C ... 35 °C |
| Storage temperature | 0 °C ... 35 °C |
| Degree of protection | IP20 |
| Emergency Lighting system | CGLine+ monitoring and management |
| Interface | Web server embedded |

Ordering details

| Type | Scope of supply | Order No. |
|--------------------------------|--|----------------|
| CGLine+ Web Compact Controller | Wall mounted controller with LCD screen and keypad | CTR160CGL2KS-L |
| CGLine+ Web Compact Controller | Wall mounted controller with LCD screen and keypad | CTR400CGL2KS-L |

Accessories

| Type | Scope of supply | Order No. |
|---------------------|-----------------|-------------|
| CGLine+ PC software | on CD-ROM | 40071361178 |

The CGLine+ Web compact controller is dedicated to optimize the monitoring and the maintenance of small and medium Emergency Lighting installations. It results in a maximization of the safety, an improvement of maintenance operations, and a reduction of the DgEL.

In association with our CGLine+ luminaires with 0 spare parts replacement for 10 years, Eaton offers more peace of mind to building owners and users.

Changes in the products, to the information contained in this document, and to prices are reserved, as are errors and omissions. Only order confirmations and technical documentation by Eaton is binding. Photos and pictures also do not warrant a specific layout or functionality. Their use in whatever form is subject to prior approval by Eaton.

EATON LUMINOX - CGLine+ Web Compact Controller Datasheet (PE Edition)

Key Details

- Self-contained emergency luminaire
- CGLine+ compatible
- 3-hour duration

Original manufacturer / supplier datasheet pages are included after this cover page for technical reference.

CGLine+ Web Compact Controller with integrated web server



CGLine+ Web Compact Controller

- For connecting up to 160 or 400 luminaires in 2 lines
- HMI with TFT LCD screen 320*480 and keypad
- T9 predictive text for friendly usage of the keypad
- Led status for Emergency Lighting installation
- The integrated web server enables there to be convenient visualization, control and monitoring
- Up to 9 additional web compact controllers managed within the same web server connection
- Unique ID per luminaires assigned by the manufacturer
- Automatic luminaire search function requiring no manual addressing
- Simple sorting using unrestricted short address assignment
- Unrestricted entry of target location names for the luminaires with up to 20 characters
- Clearly-shown allocation of luminaires to 4 zones of 20 luminaires per line
- Automatic function test and duration test
- Up to 8 test groups per luminaire can be defined for the function test (FT) and duration test (DT)
- Electronic log book storage for a period of minimum 4 years
- E-mail service for sending automatic e-mail in case of malfunctions to up to 10 e-mail addresses, assignable to 2 escalation groups
- Blocking the emergency lighting function during non-operational periods (all/per bus line/ per zone/per luminaire)
- Luminaires in maintained mode switchable (all/per bus line/per zone/per luminaire)
- Password protected access as an administrator or user
- Visualisation of luminaires in up to 30 different building layouts with the web server
- Efficient and convenient analysis of the log book using the CGLine+ PC software
- Compliant with the highest industry cybersecurity requirements
- Maintenance and replacement of luminaire with the local HMI
- Maintenance and replacement of luminaire with the web server interface
- Compatible with the new increased affordance (IA) functionality

Dimensional drawings, data in mm

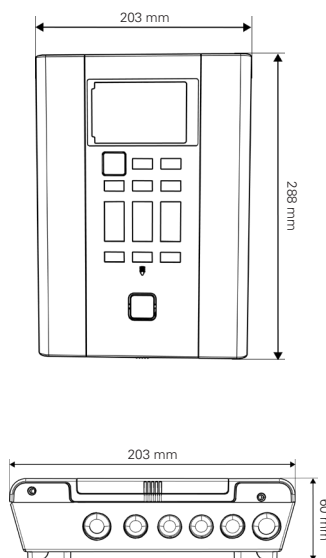

| | |
|---------------------------------|---------------------------------------|
| Dimensions | 288 x 203 x 60 mm |
| Housing type | Wall mounted |
| Screen | 3,5 inch TFT LCD screen (320 x 480) |
| Power supply | 230 V AC, 50/60 Hz |
| Power consumption | < 4 W in standby, < 34 W at full load |
| Connection terminals | max. 2.5 mm ² |
| Permissible ambient temperature | 0 °C ... 35 °C |
| Storage temperature | 0 °C ... 35 °C |
| Degree of protection | IP20 |
| Emergency Lighting system | CGLine+ monitoring and management |
| Interface | Web server embedded |

Ordering details

| Type | Scope of supply | Order No. |
|--------------------------------|--|----------------|
| CGLine+ Web Compact Controller | Wall mounted controller with LCD screen and keypad | CTR160CGL2KS-L |
| CGLine+ Web Compact Controller | Wall mounted controller with LCD screen and keypad | CTR400CGL2KS-L |

Accessories

| Type | Scope of supply | Order No. |
|---------------------|-----------------|-------------|
| CGLine+ PC software | on CD-ROM | 40071361178 |

The CGLine+ Web compact controller is dedicated to optimize the monitoring and the maintenance of small and medium Emergency Lighting installations. It results in a maximization of the safety, an improvement of maintenance operations and a reduction of the OpEx. In association with our CGLine+ luminaires with 0 spare parts replacement for 10 years, Eaton offers more piece of mind to building owners and users.

Changes to the products, to the information contained in this document, and to prices are reserved; so are errors and omissions. Only order confirmations and technical documentation by Eaton is binding. Photos and pictures also do not warrant a specific layout or functionality. Their use in whatever form is subject to prior approval by Eaton.

CGLine+ self-contained luminaire system

CGLine+ Web Compact Controller



Powering Business Worldwide

Set-up of the CGLine+ Web Compact Controller



1 Status LED indicator for the EL installation:

- Green = OK
- Green blinking = at least 1 luminaire is performing a function test or duration test
- Red : Failure / event

2 TFT LCD screen with all menu, parameters and alarms

3 Keypad for navigation in the menu and set parameters

4 USB-1 host, for connecting a USB stick with LED indicator

5 USB2 device, for connecting to PC with LED indicator

6 LAN (RJ45), with LED display

- Green = connected (link)
- Yellow = data transfer (traffic)

7 Cables entries for :

- Connection CGLine+ bus line 1-2
- PE/L/N 230V 50/60Hz
- S1/S2 = Block input
- In1, In2 = 2 x digital inputs
- 11, 12, 14, 21, 22, 24 = 2x relay outputs

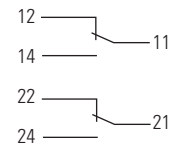

CGLine+ in operation

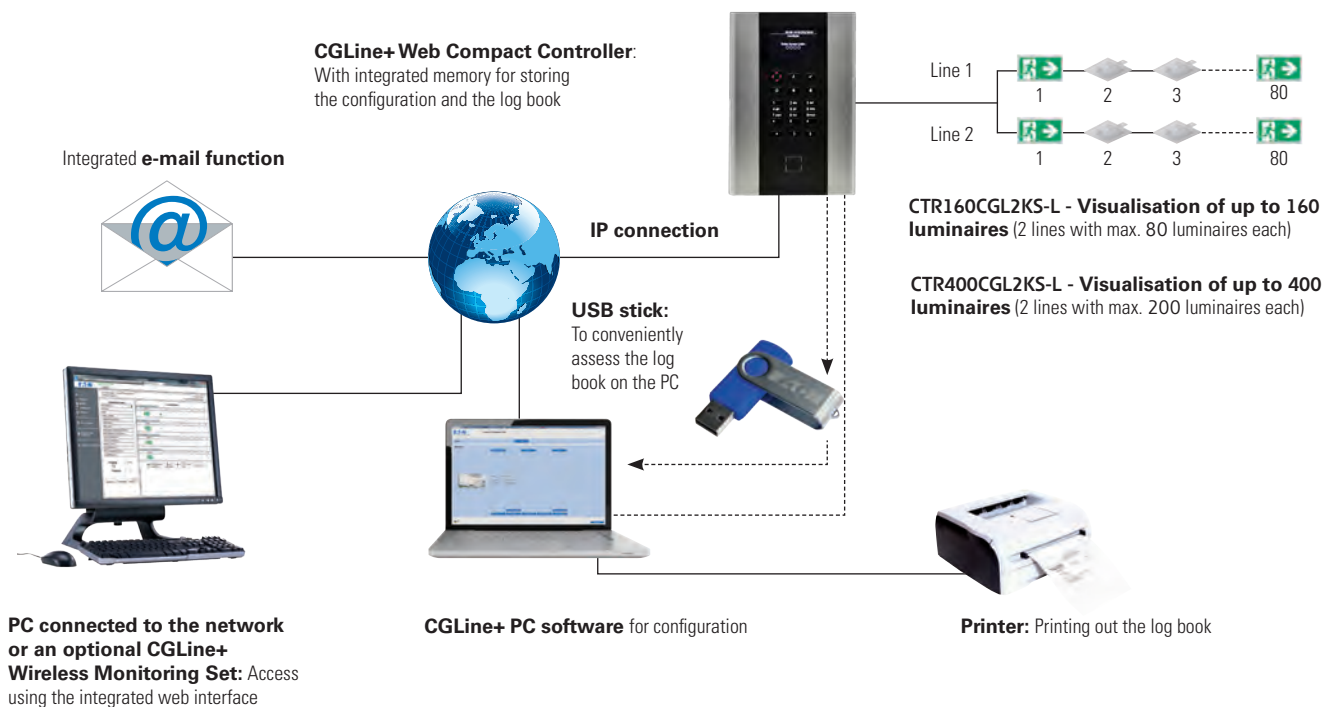

Changes to the products, to the information contained in this document, and to prices are reserved; so are errors and omissions. Only order confirmations and technical documentation by Eaton is binding. Photos and pictures also do not warrant a specific layout or functionality. Their use in whatever form is subject to prior approval by Eaton.

Self-contained luminaires

SafeLite



Powering Business Worldwide

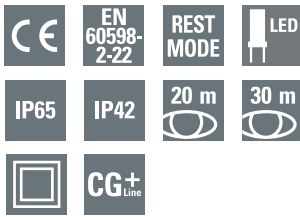

Safelite self-contained luminaires

- Compliant with EC standards
- EN certified
- All applications covered (Escape route, Anti-panic, Exit sign)
- One product throughout installation for same look and feel across the building
- Accessories available for a better integration in all buildings
- Easily installed as retro fit due to good performance ensuring scheme compliance
- 3h Duration
- Latest generation LEDs with high lumen/watt ratio



Recessed base:



Cone Diffuser:



Plexi Diffuser:



Recessed box:



Wire guard :



Safelite

| | |
|---------------------------------|--|
| Function | Use either as an emergency luminaire or exit sign |
| Testing system | Stand Alone or addressable versions (CGLine+) |
| Housing | Polycarbonate, Glow wire test : 850°C, RAL9003 |
| Type of mounting | Surface Options : Recessed base for ceiling, double sided diffuser, set of 3 exit legends (L, R, D) |
| Terminals | up to 1x2,5 mm ² per connection |
| Degree of protection | IK04, IP42 or IK07, IP65 |
| Operation Mode | Non Maintained or Maintained & Non Maintained mode selectable |
| Connection voltage | 230V +/- 5% [220V-240V] 50-60Hz |
| Permissible ambient temperature | Stand Alone version : +5°C to +40°C CGLine+ version : +5°C to +45°C |
| Battery | Ni-Cd |
| Light source | LED strip |
| Duration | 3 hours |
| Viewing distance | 20m or 30m |
| Insulation class | II |
| Dimensions in mm | 20 m viewing distance version: 270 x 119 x 49 30 m viewing distance version: 371 x 170 x 62 |

SafeLite 20m

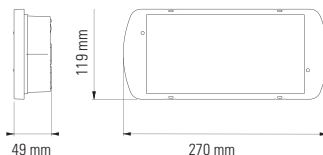

SafeLite 30m

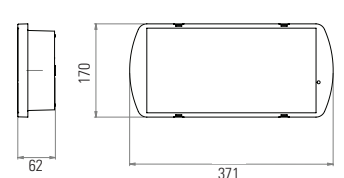

Changes to the products, to the information contained in this document, and to prices are reserved; so are errors and omissions. Only order confirmations and technical documentation by Eaton is binding. Photos and pictures also do not warrant a specific layout or functionality. Their use in whatever form is subject to prior approval by Eaton.

Self-contained luminaires

SafeLite



Powering Business Worldwide

Order codes

Consumption

| Order code | Viewing distance (m) | IP | IK | Duration (h) | Lum in emergency | Lum in mains | Operation | Consumption | | | | Battery | Weight (kg) | Adhesive Exit Legend included |
|------------------------|----------------------|----|----|--------------|------------------|--------------|-----------|-------------|------|------|-----|-------------|-------------|-------------------------------|
| | | | | | | | | NM VA | NM W | M VA | M W | | | |
| SL2NM42D3-L | 20 | 42 | 04 | 3 | 100 | - | NM | 1,7 | 1,4 | - | - | 3,6V 1.7 Ah | 0.5 | |
| SL2NM65D3-L | 20 | 65 | 07 | 3 | 100 | - | NM | 1,7 | 1,4 | - | - | 3,6V 1.7 Ah | 0.6 | |
| SL2MNM42C3C3A-L | 20 | 42 | 04 | 3 | 60 | 60 | MNM | 2,7 | 2,6 | 2,8 | 2,7 | 3,6V 0.8 Ah | 0.5 | ISO (L, R, D) |
| SL2MNM65C3C3A-L | 20 | 65 | 07 | 3 | 60 | 60 | MNM | 2,7 | 2,6 | 2,8 | 2,7 | 3,6V 0.8 Ah | 0.5 | ISO (L, R, D) |
| SL2MNM42D3C3A-L | 20 | 42 | 04 | 3 | 100 | 60 | MNM | 3,2 | 2,5 | 3,8 | 3,2 | 3,6V 1.7 Ah | 0.6 | ISO (L, R, D) |
| SL2MNM65D3C3A-L | 20 | 65 | 07 | 3 | 100 | 60 | MNM | 3,2 | 2,5 | 3,8 | 3,2 | 3,6V 1.7 Ah | 0.7 | ISO (L, R, D) |
| SL2MNM65F3C3A-L | 20 | 65 | 07 | 3 | 200 | 60 | MNM | 3,2 | 2,5 | 3,8 | 3,2 | 3,6V 2 Ah | 0.7 | ISO (L, R, D) |
| SL2-42D3D-CGL-L | 20 | 42 | 04 | 3 | 100 | 100 | MNM | 3 | 1.2 | 7 | 3,2 | 3,6V 1.7 Ah | 0.7 | |
| SL2-65D3D-CGL-L | 20 | 65 | 07 | 3 | 100 | 100 | MNM | 3 | 1.2 | 7 | 3,2 | 3,6V 1.7 Ah | 0.7 | |



Changes to the products, to the information contained in this document, and to prices are reserved; so are errors and omissions. Only order confirmations and technical documentation by Eaton is binding. Photos and pictures also do not warrant a specific layout or functionality. Their use in whatever form is subject to prior approval by Eaton.



Accessories

Wire guard - ensures high degree of protection

| | |
|-----------|--------------------------|
| SL2PG | SafeLite 20m, Wire guard |
| O-EL-GRID | SafeLite 30m, Wire guard |

Recessed base - For full recessed mounting, compatible IP42 & IP65 variants, can be associated to double side diffusers

| | |
|-------|-------------------------|
| SL2RB | SafeLite 20m, RecesBase |
| SL3RB | SafeLite 30m, RecesBase |

Recessed box

EATON LUMINOX - EMERGENCY LIGHTING SC - SafeLite - February 2024 (ME Edition)

| | |
|-------|-------------------------|
| SL2WB | SafeLite 20m, Wall Base |
|-------|-------------------------|

Opal diffuser

| | |
|-------|--------------------------|
| SL2OP | SafeLite Opal Diffuser** |
|-------|--------------------------|

**Light decrease around 5%, mesured values upon request

Wall bracket

| | |
|--------|--------------------------------|
| EL-BR1 | SafeLite 20m, 90° Wall Bracket |
|--------|--------------------------------|

Double side cone diffuser - compliant with EN1838

| | |
|-------|------------------------------|
| SL2CD | SafeLite 20m, Cone Diffuser* |
| SL3CD | SafeLite 30m, Cone Diffuser* |

*Pictograms have to be ordered separately (or re use ones delivered with luminaires).

Double side plexi diffuser

| | |
|---------|--|
| SL2PPD | SafeLite 20m, Plexi Plate, one side, Down |
| SL2PPDD | SafeLite 20m, Plexi Plate, double side, Down |
| SL2PPLR | SafeLite 20m, Plexi Plate, double side, Left & Right |
| SL3PPD | SafeLite 30m, Plexi Plate, one side, Down |
| SL3PPDD | SafeLite 30m, Plexi Plate, double side, Down |
| SL3PPLR | SafeLite 30m, Plexi Plate, double side, Left & Right |

Set of adhesive exit legends

ISO7010 format

| | |
|-------|--|
| SL23A | SafeLite 20m, 3x Adh (Left, Right, Down) |
| SL33A | SafeLite 30m, 3x Adh (Left, Right, Down) |
| SL24A | SafeLite 20m, 4x Adh (Left, Right, Down, Up) |
| SL34A | SafeLite 30m, 4x Adh (Left, Right, Down, Up) |

Other formats on demand , please liaise with the PM

Recessed Base 20m Dimensional drawings (mm)

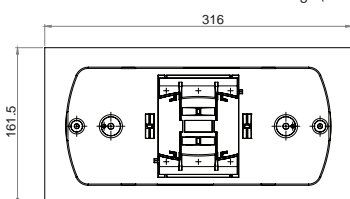

Cone Diffuser 20m Dimensional drawings (mm)

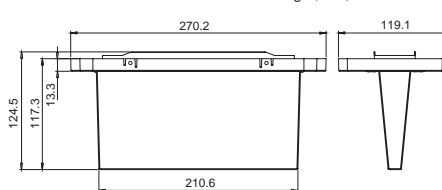

SafeLite 20m Exit Sign Plexiglass drawings (mm)

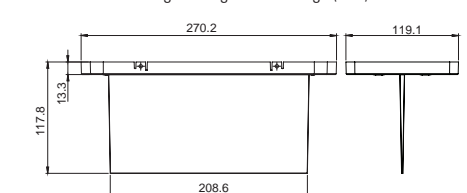

Recessed Base 30m Dimensional drawings (mm)

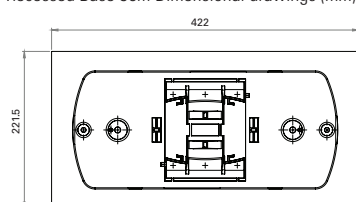

Cone Diffuser 30m Dimensional drawings (mm)

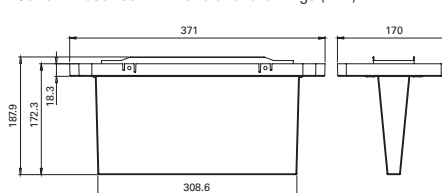

SafeLite 30m Exit Sign Plexiglass drawings (mm)

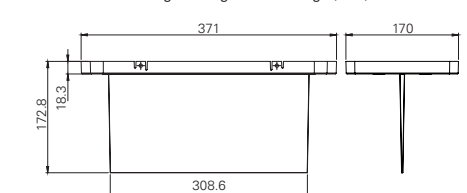

Changes to the products, to the information contained in this document, and to prices are reserved; so are errors and omissions. Only order confirmations and technical documentation by Eaton is binding. Photos and pictures also do not warrant a specific layout or functionality. Their use in whatever form is subject to prior approval by Eaton.

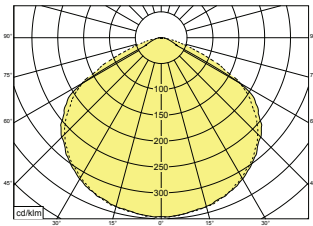

Light distribution curve

Photometric data - 20m version, 60 lm

Escape route 2m wide 1 lux min

| Mounting height [m] | Lux level directly under | | | | |
|---------------------|--------------------------|-----|-----|-----|-----|
| 2,5 | 3,4 | 2,5 | 6,6 | 6,4 | 2,4 |
| 2,8 | 2,7 | 2,4 | 6,7 | 6,6 | 2,4 |
| 3,0 | 2,3 | 2,3 | 6,8 | 6,7 | 2,3 |
| 3,5 | 1,7 | 2,1 | 6,8 | 6,7 | 2,1 |
| 4,0 | 1,3 | 1,7 | 6,6 | 6,5 | 1,7 |
| 4,5 | 1,0 | 0,8 | 6,3 | 6,2 | 0,8 |

Open (anti-panic) area 1 lux min

| Mounting height [m] | | | | |
|---------------------|-----|-----|-----|-----|
| 2,5 | 2,2 | 5,9 | 5,7 | 2,1 |
| 2,8 | 2,2 | 6,1 | 5,8 | 2,1 |
| 3,0 | 2,2 | 6,1 | 5,9 | 2,1 |
| 3,5 | 2,1 | 6,2 | 6,1 | 2,0 |
| 4,0 | 1,7 | 6,2 | 6,2 | 1,6 |
| 4,5 | 1,1 | 6,2 | 6,7 | 1,0 |

Open (anti-panic) area 0.5 lux min

| Mounting height [m] | | | | |
|---------------------|-----|-----|-----|-----|
| 2,5 | 2,9 | 7,2 | 6,9 | 2,8 |
| 2,8 | 3,0 | 7,5 | 7,2 | 2,9 |
| 3,0 | 3,0 | 7,7 | 7,4 | 2,9 |
| 3,5 | 3,0 | 7,9 | 7,8 | 2,9 |
| 4,0 | 2,9 | 8,3 | 8,2 | 2,8 |
| 4,5 | 2,8 | 8,5 | 8,5 | 2,7 |

Changes to the products, to the information contained in this document, and to prices are reserved; so are errors and omissions. Only order confirmations and technical documentation by Eaton is binding. Photos and pictures also do not warrant a specific layout or functionality. Their use in whatever form is subject to prior approval by Eaton.

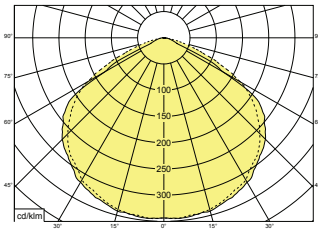

Light distribution curve

Photometric data - 20m version, 100lm

Escape route 2m wide 1 lux min

| Mounting height [m] | Lux level directly under | | | | |
|---------------------|--------------------------|-----|-----|-----|-----|
| 2,5 | 5,7 | 3,1 | 7,8 | 7,7 | 3,1 |
| 2,8 | 4,6 | 3,2 | 8,2 | 8,0 | 3,1 |
| 3,0 | 4,0 | 3,2 | 8,4 | 8,2 | 3,1 |
| 3,5 | 2,9 | 3,2 | 8,8 | 8,5 | 3,1 |
| 4,0 | 2,2 | 3,0 | 8,9 | 8,6 | 3,0 |
| 4,5 | 1,8 | 2,8 | 8,9 | 8,7 | 2,8 |
| 5,0 | 1,4 | 2,5 | 8,8 | 8,6 | 2,4 |

Mounting height for 5 lux below 2.8 meters

Open (anti-panic) area 1 lux min

| Mounting height [m] | | | | |
|---------------------|-----|-----|-----|-----|
| 2,5 | 2,7 | 6,9 | 6,6 | 2,6 |
| 2,8 | 2,7 | 7,1 | 6,9 | 2,6 |
| 3,0 | 2,8 | 7,3 | 7,0 | 2,7 |
| 3,5 | 2,8 | 7,7 | 7,4 | 2,7 |
| 4,0 | 2,7 | 7,9 | 7,7 | 2,6 |
| 4,5 | 2,5 | 8,1 | 8,0 | 2,4 |
| 5,0 | 2,3 | 8,2 | 8,2 | 2,2 |

Open (anti-panic) area 0.5 lux min

| Mounting height [m] | | | | |
|---------------------|-----|------|------|-----|
| 2,5 | 3,3 | 7,7 | 8,0 | 3,3 |
| 2,8 | 3,4 | 8,6 | 8,6 | 3,3 |
| 3,0 | 3,5 | 8,9 | 8,8 | 3,4 |
| 3,5 | 3,6 | 9,7 | 9,7 | 3,5 |
| 4,0 | 3,7 | 10,1 | 10,0 | 3,6 |
| 4,5 | 3,7 | 10,5 | 10,3 | 3,6 |
| 5,0 | 3,6 | 10,7 | 10,6 | 3,6 |

Changes to the products, to the information contained in this document, and to prices are reserved; so are errors and omissions. Only order confirmations and technical documentation by Eaton is binding. Photos and pictures also do not warrant a specific layout or functionality. Their use in whatever form is subject to prior approval by Eaton.

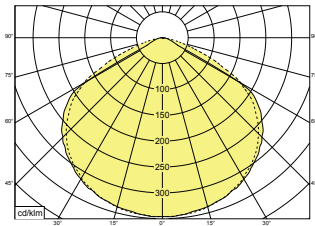

Light distribution curve

Photometric data - 20m version, 200lm

Escape route 2m wide 1 lux min

| Mounting height [m] | Lux level directly under | | | | |
|---------------------|--------------------------|-----|------|------|-----|
| 2,5 | 10,0 | 3,9 | 8,7 | 9,2 | 3,7 |
| 2,8 | 8,0 | 4,0 | 9,4 | 9,7 | 3,9 |
| 3,0 | 7,0 | 4,0 | 9,8 | 9,9 | 3,9 |
| 3,5 | 5,1 | 4,1 | 10,8 | 10,5 | 4,1 |
| 4,0 | 3,9 | 4,2 | 11,2 | 11,0 | 4,0 |
| 4,5 | 3,1 | 4,2 | 11,5 | 11,2 | 4,1 |
| 5,0 | 2,5 | 4,1 | 11,7 | 11,4 | 4,0 |
| 5,5 | 2,0 | 3,9 | 11,8 | 11,6 | 3,8 |
| 6,0 | 1,7 | 3,7 | 11,8 | 11,6 | 3,6 |
| 6,5 | 1,5 | 3,3 | 11,6 | 11,5 | 3,3 |
| 7,0 | 1,3 | 2,8 | 11,4 | 11,3 | 2,7 |

Mounting height for 5 lux below 3.7 meters

Open (anti-panic) area 1 lux min

| Mounting height [m] | | | | |
|---------------------|-----|------|------|-----|
| 2,5 | 3,2 | 7,9 | 7,8 | 3,1 |
| 2,8 | 3,3 | 8,3 | 8,1 | 3,2 |
| 3,0 | 3,4 | 8,5 | 8,3 | 3,3 |
| 3,5 | 3,5 | 9,4 | 8,9 | 3,3 |
| 4,0 | 3,5 | 9,7 | 9,4 | 3,4 |
| 4,5 | 3,5 | 10,0 | 9,8 | 3,4 |
| 5,0 | 3,4 | 10,4 | 10,1 | 3,3 |
| 5,5 | 3,3 | 10,6 | 10,3 | 3,2 |
| 6,0 | 3,2 | 10,7 | 10,5 | 3,1 |
| 6,5 | 2,9 | 10,8 | 10,7 | 2,8 |
| 7,0 | 2,5 | 10,8 | 11,0 | 2,4 |

Open (anti-panic) area 0.5 lux min

| Mounting height [m] | | | | |
|---------------------|-----|------|------|-----|
| 2,5 | 3,9 | 9,1 | 9,5 | 3,7 |
| 2,8 | 4,1 | 9,4 | 9,8 | 3,9 |
| 3,0 | 4,1 | 9,7 | 10,1 | 4,0 |
| 3,5 | 4,3 | 11,0 | 10,9 | 4,2 |
| 4,0 | 4,5 | 11,8 | 11,6 | 4,4 |
| 4,5 | 4,6 | 12,6 | 12,4 | 4,5 |
| 5,0 | 4,7 | 13,0 | 12,8 | 4,6 |
| 5,5 | 4,7 | 13,4 | 13,1 | 4,6 |
| 6,0 | 4,7 | 13,7 | 13,5 | 4,6 |
| 6,5 | 4,6 | 14,1 | 13,9 | 4,6 |
| 7,0 | 4,5 | 14,6 | 14,3 | 4,4 |

Changes to the products, to the information contained in this document, and to prices are reserved; so are errors and omissions. Only order confirmations and technical documentation by Eaton is binding. Photos and pictures also do not warrant a specific layout or functionality. Their use in whatever form is subject to prior approval by Eaton.

NexiTech LED

Safety and Exit Sign Luminaires with the same design



Powering Business Worldwide

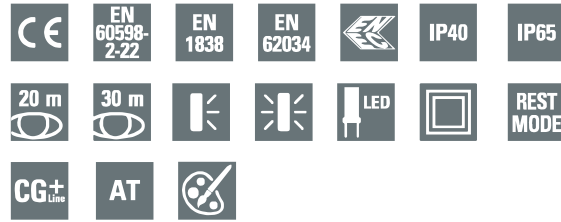

- 150lm & 300lm output flux
- Comparable to 8 and 11W fluorescent lamp
- Ni-Cd HT high quality batteries

Light Source:

LED strip

The modern style, the simplicity of the shapes and the high quality surfaces make NexiTech LED ideal for any architectural context, while the precision of the mechanics and the sophisticated electronics guarantee a full unmatched reliability. The latest generation of LED light source provides a good and uniform light distribution.

Material:

Base and reflector white polycarbonate

Diffuser clear polycarbonate

Protection degree IP40 and IP65 with the accessory kit

Ni-Cd battery

The wide range of accessories allows installation on a wall or ceiling, surface or recessed in indoor and harsh environments, thanks to the IP65 protection kit. It is also possible to use it as single or double-sided exit sign and to combine exit and safety lighting functions in one product.

This range is composed of maintained and non-maintained variants, 3h duration version, 300lm light output. The use of LEDs, automatic testing and monitoring devices (CG Line+) significantly reduce the operating and maintenance costs of the installation.

Installation options:

Wall and ceiling mounting

Surface or recessed installation in false ceiling and bricks wall

Single side glue-less ISO7010 pictograms with

20m viewing distance

Double side ISO7010 panels with 20 or 30m of viewing distance

Dimensions in mm

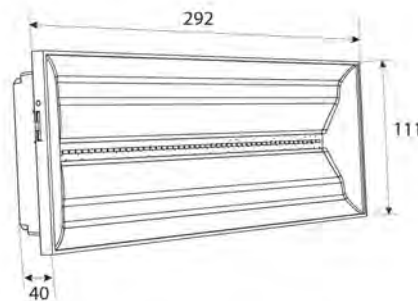

Operation:

Maintained and Non-Maintained mode on all version

Fixed 60lm output in Maintained mode for all variants for high energy saving

3h duration

Rest Mode and Tests via remote command

24h recharge period

Autotest is now for all

The reliability and the guarantee of operation are now within everyone's reach. We chose to design NexiTech LED starting directly from models with built-in diagnostic functions, all the self-contained versions (with battery on board) are equipped with a self-test system that performs automatic tests in accordance with standard EN62034 and EN50172.

Top level signalization

The pictograms, optional and available upon request, conform to the international standard ISO7010, have no glue and can be repositioned at will and with ease, without a complex installation. They are placed between the diffuser and reflector creating a translucency which finds its maximum aesthetic applications when recessed into the wall.

Applications:

Schools, universities, commercial malls, stores, offices, public administration and all indoor generic environments

Safety antipanic lighting and escape route lighting

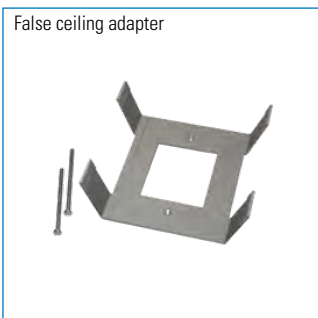

NexiTech LED

Safety and Exit Sign Luminaires with the same design



Powering Business Worldwide

With double-side pictograms



Viewing distance: 20 or 30m

With single-side pictograms



Nexi pictograms don't stick, but are placed behind transparent diffuser.

Viewing distance: 20m

45° Wall Bracket (IP40/IP65)



Light the floor from the wall

Nexi LED frame



| Order code | Description | | | | | |
|----------------------|----------------------------------|---------------|--------|----|--------------------|-----------------------------|
| NEXI1 50-3H-CGL-L | NexiTech LED 150 3h CGLine+ | 1.3 W - 3.1 W | 150 Lm | 3h | 7.2V - 1.7Ah Ni-Cd | Maintained / Non-Maintained |
| NEXI1 50-3H-CGL-IP-L | NexiTech LED 150 3h IP65 CGLine+ | 1.3 W - 3.1 W | 150 Lm | 3h | 7.2V - 1.7Ah Ni-Cd | Maintained / Non-Maintained |
| NEXI3 00-3H-CGL-L | NexiTech LED 300 3h CGLine+ | 2 W - 3.2 W | 300 Lm | 3h | 7.2V - 1.7Ah Ni-Cd | Maintained / Non-Maintained |
| NEXI3 00-3H-CGL-IP-L | NexiTech LED 300 3h IP65 CGLine+ | 2 W - 3.2 W | 300 Lm | 3h | 7.2V - 1.7Ah Ni-Cd | Maintained / Non-Maintained |

*Non maintained - Maintained

Ordering details - Opal diffuser for Exit Sign and Safety Lighting functions

High Uniformity, complying with EN1838, suitable for Nexi LED IP40 versions

| Order code | Description | Pictogram |
|------------------|---|-----------------|
| NEXI-PLEXO-DB | NEXI PANEL OPAL 30 D-B ISO High Unifor. | 30m, Down/Blank |
| NEXI-PLEXO-DD | NEXI PANEL OPAL 30 D-D ISO High Unifor. | 30m, Down/Down |
| NEXI-PLEXO-LR | NEXI PANEL OPAL 30 L-R ISO High Unifor. | 30m, Left/Right |
| NEXI-PLEXO-UB | NEXI PANEL OPAL 30 U-B ISO High Unifor. | 30m, Up/Blank |
| NEXI-PLEXO-UU | NEXI PANEL OPAL 30 U-U ISO High Unifor. | 30m, Up/Up |
| NEXI-PLEXO-20-DB | NEXI PANEL OPAL 20 D-B ISO High Unifor. | 20m, Down/Blank |
| NEXI-PLEXO-20-DD | NEXI PANEL OPAL 20 D-D ISO High Unifor. | 20m, Down/Down |
| NEXI-PLEXO-20-LR | NEXI PANEL OPAL 20 L-R ISO High Unifor. | 20m, Left/Right |
| NEXI-PLEXO-20-UB | NEXI PANEL OPAL 20 U-B ISO High Unifor. | 20m, Up/Blank |
| NEXI-PLEXO-20-UU | NEXI PANEL OPAL 20 U-U ISO High Unifor. | 20m, Up/Up |



Nexi LED 30m viewing distance

Nexi LED 20m viewing distance

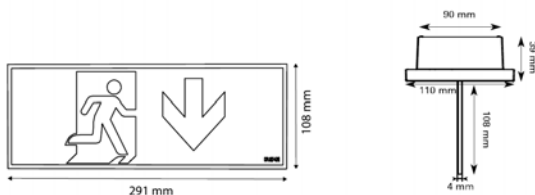

Nexi LED 30m viewing distance

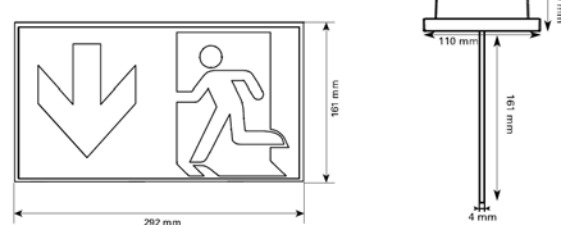

Changes to the products, to the information contained in this document, and to prices are reserved; so are errors and omissions. Only order confirmations and technical documentation by Eaton is binding. Photos and pictures also do not warrant a specific layout or functionality. Their use in whatever form is subject to prior approval by Eaton.



Nexi LED recessed using false ceiling adapter + Edge light panel



Nexi LED + Edge light panel



Nexi LED + finishing frame + Edge light panel

High Uniformity, complying with EN1838, suitable for Nexi LED IP40 versions

| Order code | Description | Pictogram |
|-----------------|------------------------------------|-----------------|
| NEXI-PLEX-20-DB | NEXI PANEL 20 D-B ISO High Unifor. | 20m, Down/Blank |
| NEXI-PLEX-20-DD | NEXI PANEL 20 D-D ISO High Unifor. | 20m, Down/Down |
| NEXI-PLEX-20-LR | NEXI PANEL 20 LR ISO High Unifor. | 20m, Left/Right |
| NEXI-PLEX-20-UB | NEXI PANEL 20 U-B ISO High Unifor. | 20m, Up/Blank |
| NEXI-PLEX-20-UU | NEXI PANEL 20 U-U ISO High Unifor. | 20m, Up/Up |
| NEXI-PLEX-DB | NEXI PANEL 30 D-B ISO High Unifor. | 30m, Down/Blank |
| NEXI-PLEX-DD | NEXI PANEL 30 D-D ISO High Unifor. | 30m, Down/Down |
| NEXI-PLEX-LR | NEXI PANEL 30 LR ISO High Unifor. | 30m, Left/Right |
| NEXI-PLEX-UB | NEXI PANEL 30 U-B ISO High Unifor. | 30m, Up/Blank |
| NEXI-PLEX-UU | NEXI PANEL 30 U-U ISO High Unifor. | 30m, Up/Up |

Standard uniformity, suitable for Nexi LED IP40 versions

| | | |
|--------------|------------------------------------|-----------------|
| NEXI-PLEXLDB | NEXI PANEL 30 D-B ISO Lite Unifor. | 30m, Down/Blank |
| NEXI-PLEXLDD | NEXI PANEL 30 D-D ISO Lite Unifor. | 30m, Down/Down |
| NEXI-PLEXLLR | NEXI PANEL 30 LR ISO Lite Unifor. | 30m, Left/Right |

Standard uniformity, suitable for Nexi LED IP65 versions

| | |
|--------------|--|
| NEXI-PLEX-IP | NEXI PANEL 30 ISO Lite Unifor. Delivered with 7 stickers |
|--------------|--|

Single-side pictograms

| | | |
|--------------|-------------------------------------|--|
| NEXI-PICTO-D | Pictogram Down ISO single-side 20m | |
| NEXI-PICTO-L | Pictogram Left ISO single-side 20m | |
| NEXI-PICTO-R | Pictogram Right ISO single-side 20m | |
| NEXI-PICTO-U | Pictogram Up ISO single-side 20m | |

Accessories

| | |
|-----------|---|
| NEXI-IP | IP65 protection kit |
| NEXI-WB45 | 45° Wall Bracket (IP40/IP65)* |
| EL-BR1 | 90° Wall Bracket (IP40/IP65)* |
| NEXI-RB | Bricks wall recessed base (cut-out 277x100mm) |
| NEXI-FC | False ceiling adapter (cut-out 272x95mm) |
| NEXI-FR | Finishing frame NexiTech LED |
| LUM10312 | Rest-Mode and Test telecommand |

* available in 2019

Changes to the products, to the information contained in this document, and to prices are reserved; so are errors and omissions. Only order confirmations and technical documentation by Eaton is binding. Photos and pictures also do not warrant a specific layout or functionality. Their use in whatever form is subject to prior approval by Eaton.

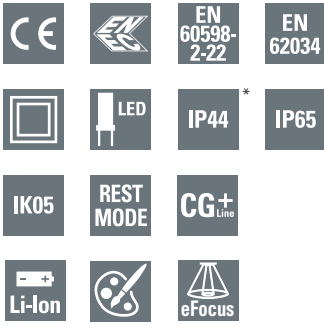

RoundTech Medium Recessed

- LED self-contained safety luminaire
- Installation up to 12m with optimum spacing of 43m for 1lux illumination
 - LowBay: Installation up to 7.5m height
 - HiBay: Installation up to 12m height
- eFocus programming: narrow and wide light distribution, programmed by the user
 - One product applicable for Escape Route or Open Area illumination
 - User / installer to define light distribution to fit the application
- Suitable for use in cinemas, theatres, shopping malls, industrial units, healthcare or hotels
- Automatic test for reduced inspection effort in autonomous installation or connection to CGLine+
- Simple fault analysis and status display via bicolor LED
- Selectable operation mode (Maintained or Non-Maintained) via switch or external contact
- Brightness selectable in mains operation (60lm) via magnet with additional setting (30%, 70%, 100%)
- Easy recessed installation via standard hole saw (Ø 64-78mm)
- Low eco footprint thanks to its eco-design, low consumption and lithium battery
- Round or Square trim available for aesthetic customization options and colours

RoundTech MR SEO



Dimensions in mm

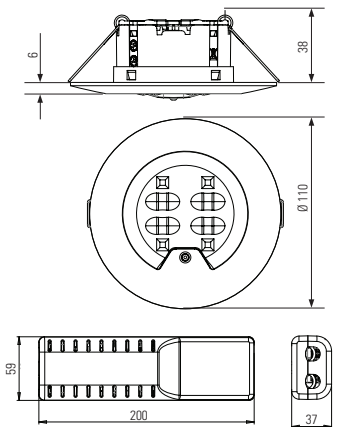

Square trim

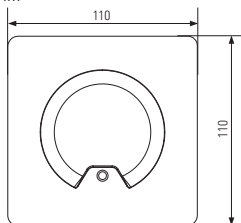

Renovation trim

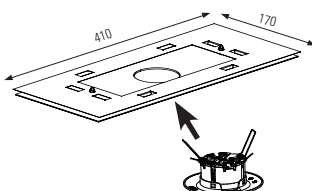

| | |
|---------------------------------|---|
| Luminous flux | 150lm, 200lm, 400lm |
| Operation | Non-Maintained, Maintained / Non-Maintained |
| Duration | 1h or 3h |
| Testing system | Test by magnet, Automatic Test, test by remote control (TLU) Telecommand |
| Connection terminals | up to 1x2.5 mm ² with screw up to 1x2.5 mm ² with screw, removable up to 2x2.5 mm ² screwless pushwire In & Out mains terminals (L, N, E) CGLine+ bus through-wiring up to 2,5 mm ² |
| Rated voltage | 220-240 V AC, 50/60 Hz |
| Housing material | Polycarbonate (850 °C glow wire resistant) |
| Housing colour | White RAL9003 (custom color variants available) |
| Insulation Class | Class II |
| Color Rendering Index | R70 |
| Color Temperature | 5700K |
| Light source | 4 LEDs Escape Route / 4 LEDs Open Area |
| Permissible ambient temperature | +5°C to +45°C |

Ordering details

| Order code | Description | Icons |
|---|---------------------------------------|---|
| Stand Alone | | |
| RT2RSO150SA3HL | RoundTech Med. Recessed SA NM IP44 | Open area 0.6VA/0.3W 3h 150 lm LiFePO4 3.2V / 3Ah |
| CGLine+ | | |
| RT2RSEO200CGL3HIPL | RoundTech Med. Recessed CGL+ MNM IP65 | ✓ 1.8VA/1.1W 3h 200 lm LiFePO4 3.2V / 3Ah |
| CGLine+ High bay variant for application up to 12m of height | | |
| RT2RHEO200CGL3HIPL | RoundTech Med. Recessed CGL+ MNM IP65 | ✓ 1.8VA/1.1W 3h 200 lm LiFePO4 3.2V / 3Ah |

Accessories

| | | Black mat RAL9005 | Dark Grey RAL7015 | Silver gloss RAL9007 |
|--|--|----------------------|----------------------|-------------------------|
| | RT2R-RT Round trim for RoundTech Medium Recessed | RT2R-RTB | RT2R-RTG | RT2R-RTS |
| | RT2R-ST Square trim for RoundTech Medium Recessed | RT2R-STB | RT2R-STG | RT2R-STS |
| | RT2R-RP Renovation Plate for RoundTech medium Recessed | | | |
| | RT2R-BAT1 Battery Pack, LifePO4 3.2V 1.5Ah | | | |
| | RT2R-BAT3 Battery Pack, LifePO4 3.2V 3Ah | | | |
| | EMN Eaton Magnet for configuration and tests | | | |

Changes to the products, to the information contained in this document, and to prices are reserved; so are errors and omissions. Only order confirmations and technical documentation by Eaton is binding. Photos and pictures also do not warrant a specific layout or functionality. Their use in whatever form is subject to prior approval by Eaton.

* Degree of protection of the luminaire: IP44 or IP65 (Once installed in the ceiling, the luminaire face is rated IP44 or IP65)
Degree of protection of the module housing: IP20

Safety Luminaire

RoundTech MR SEO



Powering Business Worldwide

eFocus, Escape Route light distribution, enables installations for corridors, escape routes and maximizes the distance between lighting fixtures. A maximum spacing of up to 43m between luminaires reduces the number of required light points and an application range from 2.5m up to 12m for 1Lux, enables mounting at the normally occurring heights.

RoundTech MR Escape Route light distribution

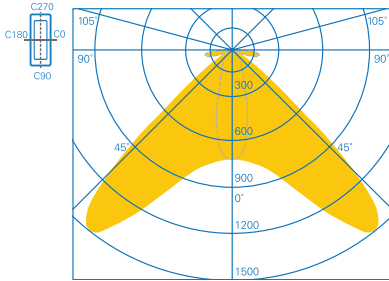

Ceiling mounting,
Escape Route, HiBay

HiBay - Planning help for RoundTech 1.0 lx / 0.5lx

Maintenance factor MF = 94 %, battery operation, ceiling mounting and distances in m

| Mounting height [m] | Lux level directly under | Mounting configurations | | | |
|---------------------|--------------------------|-------------------------|-----------|------------|-------------|
| | | | | | |
| 2,5 | 23,4 | 2,1 (2,6) | 5,2 (5,9) | 3,6 (4,1) | 8,1 (8,7) |
| 3,0 | 16,2 | 2,1 (2,8) | 5,6 (6,7) | 4,0 (4,6) | 9,1 (10,3) |
| 3,5 | 11,9 | 2,1 (2,9) | 5,9 (7,3) | 4,4 (5,0) | 10,1 (11,5) |
| 4,0 | 9,1 | 2,1 (3,0) | 6,0 (7,7) | 4,8 (5,5) | 11,0 (12,5) |
| 5,0 | 5,8 | 2,1 (3,0) | 6,0 (8,3) | 5,6 (6,3) | 12,7 (14,4) |
| 6,0 | 4,0 | 2,0 (2,9) | 5,9 (8,6) | 6,4 (7,1) | 14,3 (16,2) |
| 7,5 | 2,6 | 1,9 (2,9) | 5,8 (8,4) | 7,5 (8,2) | 16,5 (18,6) |
| 9,0 | 1,8 | 1,8 (2,8) | 5,7 (8,3) | 8,4 (9,4) | 18,9 (21,0) |
| 10,0 | 1,4 | 1,6 (2,7) | 5,5 (8,3) | 9,0 (10,2) | 20,4 (22,5) |
| 11,0 | 1,2 | 1,4 (2,7) | 5,4 (8,2) | 9,3 (10,9) | 21,8 (24,0) |
| 12,0 | 1,0 | 0,4 (2,7) | 5,3 (8,1) | 9,3 (11,5) | 23,1 (25,6) |

Ceiling mounting
Escape route
center
200lm HiBay

RoundTech MR Escape Route light distribution

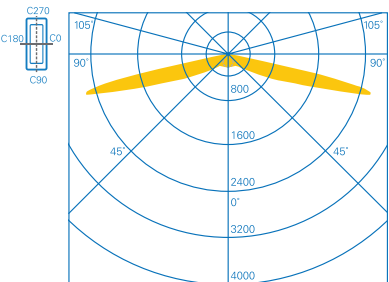

Ceiling mounting,
Escape Route, LowBay

LowBay - Planning help for RoundTech 1.0 lx / 0.5lx

Maintenance factor MF = 94 %, battery operation, ceiling mounting and distances in m

| Mounting height [m] | Lux level directly under | Mounting configurations | | | |
|---------------------|--------------------------|-------------------------|-----------|-------------|-------------|
| | | | | | |
| 3,0 | 10,9 | 2,5 (3,1) | 6,3 (7,7) | 11,2 (12,2) | 24,4 (26,2) |
| 3,5 | 8,0 | 2,7 (3,3) | 6,6 (6,6) | 12,5 (13,7) | 27,4 (29,7) |
| 4,0 | 6,1 | 2,9 (3,5) | 6,9 (6,9) | 13,7 (15,2) | 30,4 (33,0) |
| 5,0 | 3,9 | 3,2 (3,8) | 7,6 (7,6) | 15,6 (17,8) | 35,7 (39,1) |
| 6,0 | 2,7 | 3,4 (4,2) | 8,4 (8,4) | 16,1 (20,1) | 40,2 (44,9) |
| 7,0 | 2,0 | 3,5 (4,5) | 9,1 (9,1) | 12,6 (21,9) | 43,0 (50,1) |
| 7,5 | 1,7 | 3,4 (4,6) | 9,3 (9,3) | 11,3 (22,6) | 42,3 (52,6) |
| 2,5 | 7,8 | 1,9 (2,3) | 4,7 (5,9) | 8,9 (9,7) | 19,5 (21,1) |
| 3,0 | 5,4 | 2,1 (2,5) | 5,0 (6,3) | 10,0 (11,2) | 22,4 (24,4) |
| 3,5 | 4,0 | 2,3 (2,7) | 5,4 (6,6) | 10,9 (12,5) | 25,0 (27,4) |
| 4,0 | 3,0 | 2,4 (2,9) | 5,8 (6,9) | 11,5 (13,7) | 27,4 (30,4) |
| 5,0 | 1,9 | 2,4 (3,2) | 6,4 (7,6) | 8,8 (15,6) | 30,4 (35,7) |
| 6,0 | 1,3 | 2,1 (3,4) | 6,8 (8,4) | 2,9 (16,1) | 26,6 (40,2) |

Ceiling mounting
Escape route
center
200lm LowBay



Escape route for 1 lux

* Spacing tables above are examples of performance of certain models with specific lumen output, installed on ceiling and specific heights. Complete performance characteristics for all models and all installation heights and can be derived by the use of the LDT files available on request.

Points of emphasis

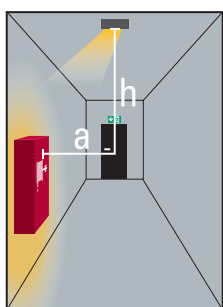

200lm with maintenance factor 0.94

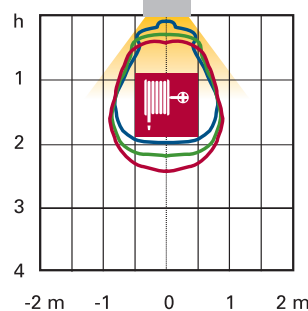

400lm with maintenance factor 0.94

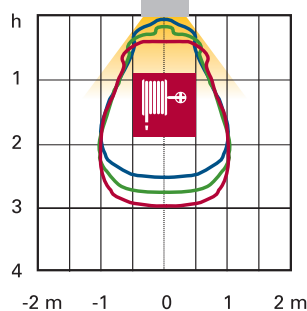

Area in which a minimum illuminance of 5lx is achieved, depending on distance a and the rated operating time:

a = 2.0 m SE

a = 1.5 m SE

a = 1.0 m SE

Rotation during application of the light head is required in order to illuminate safety points.



eFocus, Open Area light distribution, enables installations for large areas where no fixed escape route is defined, meaning that the complete area must be illuminated. A maximum spacing of up to 24.9m between luminaires reduces the number of required light points and an application range from 2.5m up to 16m for 0.5Lux, enables mounting at the normally occurring heights.

RoundTech MR Escape Route light distribution

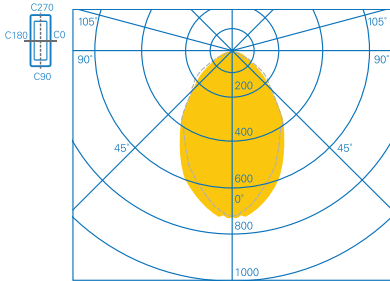

Ceiling mounting,
Open area, HiBay

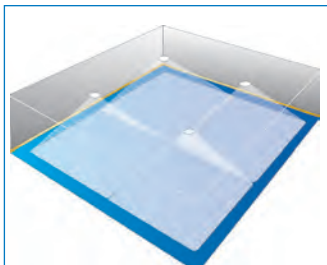

Open area for 0.5 lux

HiBay - Planning help for RoundTech 1.0 lx / 0.5lx

Maintenance factor MF = 94 %, battery operation, ceiling mounting and distances in m

| Luminaire type | Height (m) | Distance for 1 lx (0.5 lx) | | | |
|----------------|------------|----------------------------|-------------|-----------|-------------|
| | | | | | |
| | 3,0 | 2,8 (3,4) | 6,9 (8,2) | 2,8 (3,4) | 6,8 (8,2) |
| | 3,5 | 3,0 (3,6) | 7,3 (8,8) | 3,0 (3,6) | 7,2 (8,8) |
| | 4,0 | 3,1 (3,7) | 7,8 (9,4) | 3,1 (3,7) | 7,6 (9,4) |
| | 4,5 | 3,2 (3,9) | 8,2 (9,9) | 3,2 (3,9) | 8,0 (9,8) |
| | 5,5 | 3,3 (4,2) | 9,0 (10,8) | 3,3 (4,2) | 8,8 (10,6) |
| | 6,5 | 3,4 (4,4) | 9,6 (11,6) | 3,4 (4,4) | 9,4 (11,4) |
| | 8,0 | 3,3 (4,5) | 10,2 (12,8) | 3,3 (4,5) | 10,1 (12,6) |
| | 9,0 | 3,1 (4,6) | 10,6 (13,4) | 3,1 (4,6) | 10,5 (13,2) |
| | 10,0 | 2,9 (4,5) | 10,8 (14,0) | 2,9 (4,5) | 10,6 (13,8) |
| | 12,0 | 0,0 (4,3) | 0,0 (14,7) | 0,0 (4,3) | 0,0 (14,6) |
| | 13,0 | 0,0 (4,1) | 0,0 (15,0) | 0,0 (4,1) | 0,0 (14,9) |
| | 14,0 | 0,0 (3,9) | 0,0 (15,1) | 0,0 (3,9) | 0,0 (15,1) |
| | 15,0 | 0,0 (3,6) | 0,0 (15,1) | 0,0 (3,6) | 0,0 (15,4) |
| | 16,0 | 0,0 (3,2) | 0,0 (15,1) | 0,0 (3,2) | 0,0 (15,5) |

Ceiling mounting
Room illumination
200lm HiBay

* Spacing tables above are examples of performance of certain models with specific lumen output, installed on ceiling and specific heights. Complete performance characteristics for all models and all installation heights and can be derived by the use of the LDT files available on request.

Points of emphasis

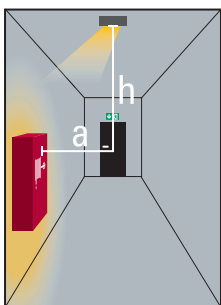

200lm with maintenance factor 0.94

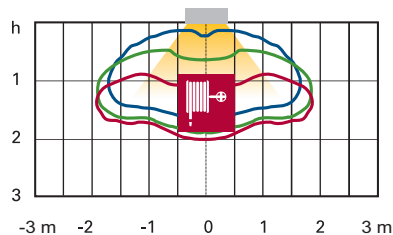

400lm with maintenance factor 0.94

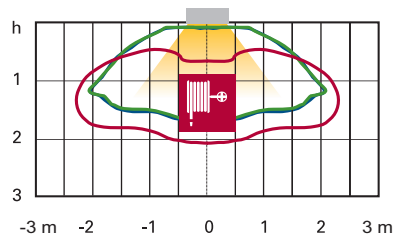

Area in which a minimum illuminance of 5lx is achieved, depending on distance a and the rated operating time:

a = 2.0 m SO

a = 1.5 m SO

a = 1.0 m SO

Rotation during application of the light head is required in order to illuminate safety points.

Changes to the products, to the information contained in this document, and to prices are reserved; so are errors and omissions. Only order confirmations and technical documentation by Eaton is binding. Photos and pictures also do not warrant a specific layout or functionality. Their use in whatever form is subject to prior approval by Eaton.

RoundTech MR
Open area light distribution

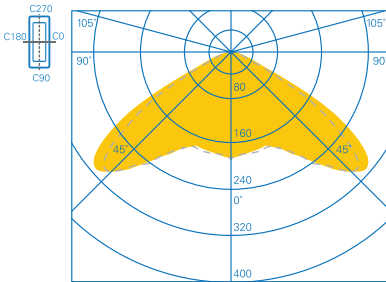

Ceiling mounting,
Open area, LowBay

LowBay - Planning help for RoundTech 1.0 lx / 0.5lx

Maintenance factor MF = 94 %, battery operation, ceiling mounting and distances in m

| Luminaire type | Height (m) | Distance for 1 lx (0.5 lx) | | | |
|---|------------|----------------------------|-------------|-------------|-------------|
| | | | | | |
| Ceiling mounting Room illumination 400lm LowBay | 2,5 | 4,6 (5,3) | 10,0 (11,1) | 4,6 (5,3) | 10,5 (11,6) |
| | 3,0 | 5,0 (5,9) | 11,3 (12,6) | 5,0 (5,9) | 11,9 (13,2) |
| | 3,5 | 5,3 (6,4) | 12,5 (14,0) | 5,3 (6,4) | 13,1 (14,8) |
| | 4,0 | 5,5 (6,7) | 13,5 (15,4) | 5,5 (6,7) | 14,2 (16,2) |
| | 4,5 | 5,6 (7,1) | 14,3 (16,6) | 5,6 (7,1) | 15,1 (17,5) |
| | 5,0 | 5,6 (7,4) | 14,9 (17,7) | 5,6 (7,4) | 15,9 (18,7) |
| | 5,5 | 5,2 (7,6) | 15,3 (18,8) | 5,2 (7,6) | 16,5 (19,8) |
| Ceiling mounting Room illumination 200lm LowBay | 2,5 | 3,9 (4,6) | 8,9 (10,0) | 3,9 (4,6) | 9,3 (10,5) |
| | 3,0 | 4,1 (5,0) | 9,8 (11,3) | 4,1 (5,0) | 10,3 (11,9) |
| | 3,5 | 4,1 (5,3) | 10,5 (12,5) | 4,1 (5,3) | 11,2 (13,1) |
| | 4,0 | 3,5 (5,5) | 11,3 (13,5) | 3,5 (5,5) | 11,7 (14,2) |
| Ceiling mounting Room illumination 150lm LowBay | 2,5 | 3,6 (4,3) | 8,4 (9,5) | 3,6 (4,3) | 8,8 (10,0) |
| | 3,0 | 3,6 (4,6) | 9,1 (10,7) | 3,6 (4,6) | 9,6 (11,3) |
| | 3,5 | 3,0 (4,9) | 9,9 (11,8) | 3,0 (4,9) | 10,2 (12,3) |
| | 4,0 | 2,2 (4,9) | 10,3 (12,5) | 2,2 (4,9) | 10,4 (13,3) |
| | 4,5 | 3,8 (4,8) | 13,1 (13,0) | 3,8 (4,8) | 2,4 (14,0) |
| 5,0 | 3,5 (4,0) | 2,0 (14,0) | 3,5 (4,0) | 14,3 (14,4) | |

* Spacing tables above are examples of performance of certain models with specific lumen output, installed on ceiling and specific heights. Complete performance characteristics for all models and all installation heights and can be derived by the use of the LDT files available on request.

Changes to the products, to the information contained in this document, and to prices are reserved; so are errors and omissions. Only order confirmations and technical documentation by Eaton is binding. Photos and pictures also do not warrant a specific layout or functionality. Their use in whatever form is subject to prior approval by Eaton.